

# N-Series

Three phase recloser  
with ADVC controller





---

<b>Applications</b>	<b>2</b>
<b>Introduction and features</b>	<b>3</b>
<b>ACR overview</b>	<b>4</b>
<b>ADVC controller series</b>	<b>5</b>
<b>ADVC block diagram</b>	<b>6</b>
<b>ADVC features</b>	<b>7</b>
<b><i>flex</i>VUE Operator Interface</b>	<b>8</b>
<b>WSOS version 5</b>	<b>9</b>
<b>General protection features</b>	<b>11</b>
<b>Advanced protection features</b>	<b>13</b>
<b>Measurement features</b>	<b>14</b>
<b>N-Series recloser - Pole mounting details</b>	<b>15</b>
<b>N-Series recloser specifications</b>	<b>16</b>
<b>Required details for order N-Series Automatic Circuit Recloser</b>	<b>17</b>
<b>Required details for order ADVC controller</b>	<b>18</b>

# Applications

## Smart grid ready

With the increasing push for advanced monitoring, reduction of outages and the need to facilitate two-way communications between supply and the distribution network, the N-Series Automatic Circuit Recloser is ready to be integrated into your Smart Grid solution.

## Loop automation

Restoring supply to your customers in the shortest possible time is the focus of recloser solutions' loop automation scheme. The loop automation scheme reconfigures protection settings, sectionalises faults, minimises affected areas, and restores network supply without the need for communications or operator intervention, using standard recloser features. A network affected by an outage is automatically reconfigured to provide power to the unaffected area when an additional supply is available. Using a combination of feeder, mid-point and tie reclosers to protect, sectionalise faults and minimise affected areas, loop automation is a distribution system automation scheme designed to restore supply to customers in the shortest possible time.

## Automatic ChangeOver (ACO)

The Automatic Changeover (ACO) system uses primary & alternative supplies, master & slave reclosers and fast communications to ensure that supply is always available for a critical load in the event of a power failure. Using a number of different set-ups including, break-before-make and make-before-break, allows the system to be configured to the exact specifications required for the critical load. The system can even be set up for one-way or two-way switching to ensure power is always available to your critical systems.

## Operation as a sectionaliser

Reclosers and sectionalisers work together to further improve feeder reliability. Using a separate RL-Series LBS/Sectionaliser, as part of a feeder automation network, detects fault passage and automatically isolates faulty sections of a network in conjunction with upstream recloser operation. To accomplish this it senses the three-phase current and voltage to count the number of recloser trip operations. When the pre-programmed number of recloser operations is reached, the controller opens the sectionaliser during the recloser dead time to isolate the downstream fault.

The N-Series Automatic Circuit Recloser (ACR) represents Schneider Electric's commitment to improved products and ongoing product development. Providing the features of a traditional recloser, plus the benefits of up to date design optimised for automation, remote control and monitoring, now or in the future.

The N-Series development was driven by customer demand for improved return on capital investment in the distribution network. After careful evaluation of customers' needs, the N-Series was developed to achieve optimum performance and reliability, making use of the latest available technology in SF6 gas insulation, vacuum interruption and microelectronics. The result is a world-class product of which we are justly proud.

In the past, distribution equipment such as reclosers have been purchased only to support load growth. Today, your customers, the electricity consumers, are demanding reduced outages and lower tariffs.

At Schneider Electric we are continually working to provide the advanced equipment needed for tomorrow's competitive electricity distribution system.

By using our technologically advanced equipment, operating costs will be reduced and capital works can be deferred through better management of existing plant. In addition, outages causing lost revenue will be reduced.

In addition to Automatic Circuit Reclosers, the Schneider Electric family of switchgear includes remotely controlled and monitored pole-mounted load break switches and sectionalisers, as well as remote control and monitoring software.

The Schneider Electric switchgear and controller product family is a complete solution for distribution system automation.

### Reduced purchase cost

- Fully integrated: no requirement for additional RTU, power supplies, batteries or enclosures. The Remote Terminal Unit (RTU) and a range of communication ports are included in the standard equipment.
- A 400 A cable connection kit is provided as part of the standard package. Optional 250 A, 630 A and 800 A cable kits are also available.

### Reduced installation costs

- Simple commissioning: configuration of the unit is from the WSOS Software or the Operator Interface (O.I.).
- All key components required for installation are included.
- Lightning arrester mounting, cable tail kit and pole-mounting brackets are provided in the standard package. An optional Voltage Transformer (VT) for auxiliary supply is available.
- Schneider Electric ACRs are ideally suited as low-cost feeder circuit-breakers in outdoor primary substations. In this application, connection into the substation control system is simple and low cost.

### Reduced operating costs

- Reduce equipment damage: the integral protection relay provides fast isolation of faults.
- The recloser constantly monitors line current and voltage without the need for additional measurement devices. This data can then be used for forward planning and optimisation of existing feeders.
- Long lifetime, low maintenance equipment reduces lifetime cost.

### DSA/SCADA compatibility

When used with a compatible Distribution System Automation (DSA) or SCADA system, Schneider Electric ACRs support remote control and monitoring to provide the following advantages:

- Reduced travel time for line crews: information on fault current and recloser status values transmitted to system control allows fast location of the faulted line section.
- This same information allows informed remote switching, reducing the affected area and quickly restoring supply.
- ACRs can be configured and settings managed from system control, without technicians having to visit each individual recloser in the field, with a consequent reduction in travelling time and improved system integrity.

### Increased customer satisfaction

- Reduced customer minutes lost: supply can be quickly restored to fault-free areas.

### Deferred capital works

- Remotely controlled and monitored reclosers give an improved knowledge of a system and provide better system control. Feeder and substation load can then be remotely managed, improving utilisation of existing plant. Purchase of new plant can then most likely be deferred for a considerable period of time.

The N-Series ACR is designed around vacuum interrupters contained in a fully welded and sealed 316 marine grade stainless steel enclosure.

The enclosure is filled with sulphur hexafluoride (SF6) gas, which has excellent electrical insulating properties, resulting in a compact and low maintenance device.

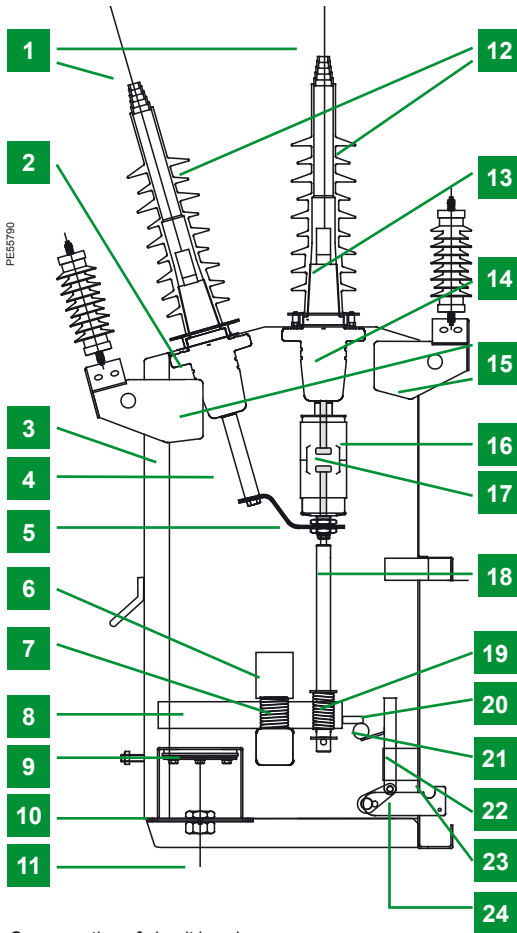

Cross section of circuit breaker

**Legend**

- |                                     |  |
|-------------------------------------|--|
| 1- Cable tails                      | 14- Capacitive Voltage Transformer (CVT) |
| 2- Current transformer              | 15- Lightning arrester and mountings     |
| 3- 316 grade stainless steel tank   | 16- Vacuum interrupter                   |
| 4- Gas filled tank                  | 17- Contacts                             |
| 5- Flexible connection              | 18- Pushrod                              |
| 6- Closing solenoid                 | 19- Contact pressure spring              |
| 7- Opening spring                   | 20- Latch                                |
| 8- Mechanism plate                  | 21- Trip bar                             |
| 9- Switch Cable Entry Module (SCEM) | 22- Trip bar armature                    |
| 10- Cable entry cover               | 23- Trip Coil                            |
| 11- Cable to control cubicle        | 24- Manual trip lever                    |
| 12- Silicone bushing boot           |  |
| 13- DIN 47 636 bushings             |  |

The N-Series circuit breaker is controlled and monitored by either the **COMPACT** or **ULTRA** ADVC Controller (ADVC).

Enclosed in a 304 (**COMPACT**) or 316 (**ULTRA**) grade stainless steel enclosure, the ADVC provides an electronic controller with Operator Interface (O.I.) that monitors the circuit breaker and provides protection, measurement, control and communication functions. Connected via a control cable, the switchgear and ADVC can form a remotely controlled and monitored ACR.

The circuit breaker is operated by sending a controlled pulse of current from a storage capacitor in the ADVC through a solenoid. This attracts the mechanism plate which in turn closes the contacts in the vacuum interrupter. The contacts are held in the closed position by latch tongues resting on the trip bar.

Opening of the contacts is achieved by releasing a controlled pulse of current from a capacitor through the trip coil. This attracts the trip bar armature, turning the trip bar and releasing the latch. The opening spring and the contact pressure springs accelerate the contacts to occur.

Epoxy bushings insulate the main circuit conductors from the tank and provide a double "O" ring seal. They also provide the necessary insulation and support for the embedded capacitive voltage transformers (CVT) and for the current transformers (CT). The bushings are DIN 47 636 (threaded option) and allow the connection of alternative cable connection elbows if desired. Lightning arrester mounting is provided for installation convenience.

A standard kit for field fitting is supplied with the circuit breaker. It contains silicone bushing boots and 3 metre lengths of 185 mm<sup>2</sup> aluminium insulated water tight cable tails rated at 400 A. This arrangement results in a recloser suitable for connection into an insulated conductor system, or a bare conductor system, as appropriate. The fully insulated system provides freedom from faults caused by birds and other wildlife.

An auxiliary voltage supply of 110, 220 or 240 volts AC is required to power the unit and, if required, a voltage transformer can be provided as a purchase option. The ADVC is connected by a control cable to the bottom of the circuit breaker through a rubber covered plug/socket arrangement.

A clearly visible external pointer shows the contact position. The recloser can be tripped from the ground by a hookstick. It can then be locked out by opening the isolating switches located on the operator control panel. These switches are physically connected in series with both the trip and close solenoids.

The ADVC interfaces to the recloser via the control cable and connects to the Switch Cable Entry Module (SCEM) in the base of the tank. The SCEM uses non-volatile memory to store all relevant calibration data, ratings and number of operations. The SCEM also provides the first stage of electrical isolation and shorting electronics to short the CTs and CVTs in the event the control cable is disconnected while current is flowing through the recloser.

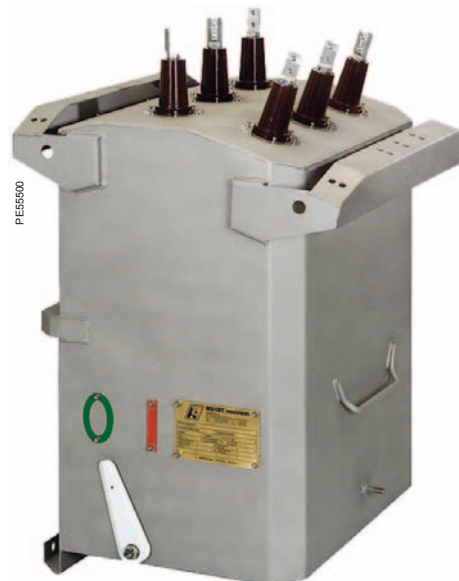

N-Series Automatic Circuit Recloser

Advanced protection, data logging & communications capabilities are made possible by the technology housed in the ADVC controller.

It has been designed especially for outdoor pole-mounted operation and is typically mounted low on the pole for ease of access by operation personnel.



ADVC ULTRA (with flexVUE)



ADVC COMPACT (with setVUE)

With a cubicle designed to minimise temperature rise from solar heating, the 304 (COMPACT) or 316 (ULTRA) grade stainless steel enclosure is used to mount the Control And Protection Enclosure (CAPE), Power Supply Unit (PSU), customer accessories and Operator Interface.

The ADVC controller series incorporates the functions of a multi-function protection relay, a circuit breaker controller, a metering unit and a remote terminal unit.

Batteries are carefully located underneath these modules to help avoid overheating so that a battery life of up to 5 years<sup>(1)</sup> can be achieved. A vandal resistant lockable stainless steel door, sealed with a rubber gasket, provides access to the Operator Interface. Vents are screened against vermin entry and all electronic parts are enclosed in a sealed die-cast enclosure which protects them from entry of moisture and condensation ensuring a long lifetime.

The COMPACT cubicle is suitable for temperatures from -10°C to 50°C, while the option of a battery heater in the ULTRA cubicle extends its operating temperature range from -40°C to 50°C.

A built-in microprocessor controlled power supply provides uninterrupted operation of not only the circuit breaker and controller, but also the communications radio or modem. These accessories are connected to a built-in user programmable radio power supply. Therefore no other power supplies are required for connection into your SCADA or distribution automation system.

Due to careful design the efficiency of all parts is extremely high, allowing a battery hold up time of up to 44 hours<sup>(2)</sup>. The architecture used has the advantage that the circuit breaker operation is independent of the high voltage supply, relying on a set of capacitors charged by the auxiliary supply.

Due to sophisticated power supply management techniques, a circuit breaker operation is always guaranteed when attempted and alarms are raised over the telemetry when auxiliary power is lost.

Communications equipment can be mounted within the ADVC controller cubicle. A V23 FSK modem, RS232, RS485 and Ethernet TCP/IP are provided as standard to support all of your communications needs.

The ADVC controller series is available in two models:

- ULTRA
- COMPACT.

The table below outlines some of the differences between the two models.

	ULTRA	COMPACT
Enclosure	316 stainless steel	304 stainless steel
Door locking	Three-point	Two-point
Customer accessory tray	Side tray Upper tray	Side tray only
Input/output modules	8 inputs, 8 outputs Optional	N/A
Battery heater	Optional	N/A
Battery	7 Ah, or 12 Ah	7 Ah
Temperature range	-40°C to 50°C (with battery heater option)	-10°C to 50°C
Auxiliary power supply	115/230 Vac	115/230 Vac
Dual AC power supply	Optional	N/A
VT supply via switchgear	Optional	Optional
DC power supply	Optional	N/A

(1) Battery replacement interval is influenced by environmental temperature.

(2) With optional 12 Ah battery, panel off and without communications devices operating.



Schneider Electric Automatic Circuit Reclosers provide many outstanding advantages to the user.

New and innovative features have been made possible by the intimate way the pole-mounted circuit breaker and control cubicle work together. The block diagram on this page shows how the two items are interfaced.

Special extended range current transformers provide a range from 1 A to 12,500 A for measurement and protection. Embedded voltage screens accurately image the primary voltage value and phase relationship at the analogue front end, allowing measurement of voltage, current, power factor and frequency in the electronic module.

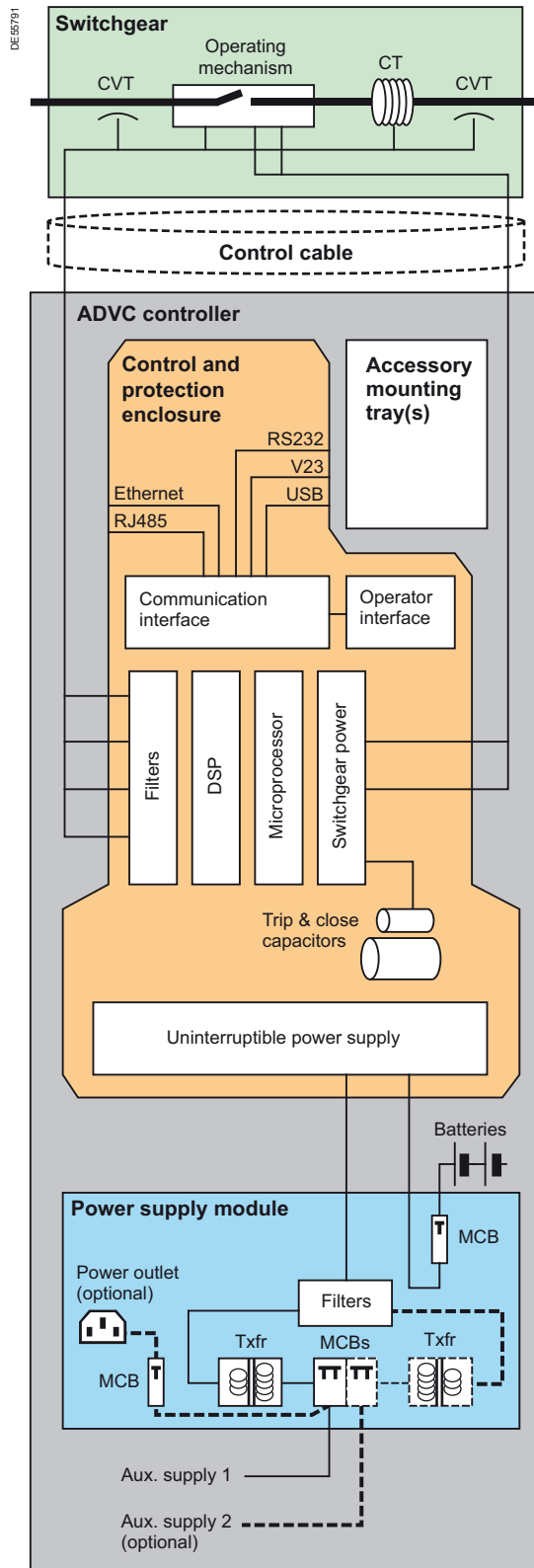

ADVC controller block diagram



Each recloser is provided with an Operator Interface. From here a user can access and program the many measurement and protection features available. Two different Operator Interfaces are available, these are:

■ **setVUE** Operator Interface

- Based on the field-proven operator panels in the previous controllers, this menu-driven interface with large LCD display offers a familiar look and feel.

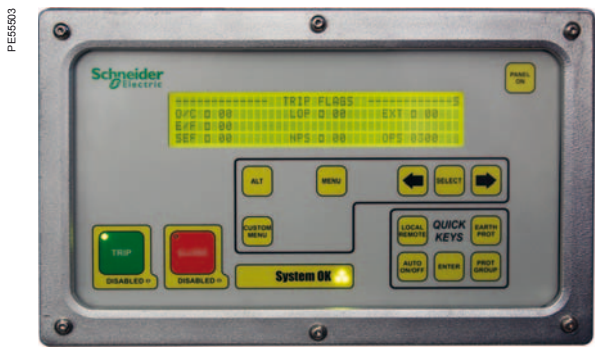

setVUE Operator Interface

■ **flexVUE** Operator Interface

- 20 status lamps provide a quick snapshot of the protection and controller status.
- 12 quick action keys are available to execute frequently used actions such as "Remote control" ON/OFF, "Reclose" ON/OFF, etc. Each key has its own status lamp to indicate the ON/OFF state.
- All status lamps and quick action keys are customisable.
- It is possible to access event and measurement data and change settings.

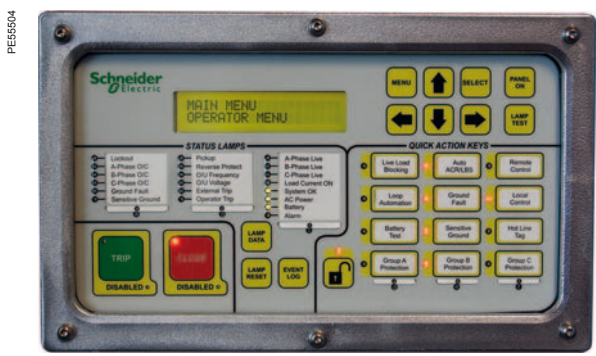

flexVUE Operator Interface

## Telemetry interface

The Schneider Electric ACR can be interfaced to your SCADA system either through its built-in V23 modem and a radio, or its RS232 ports and a modem of your choice. RS485 and Ethernet TCP/IP are also available. A variable voltage uninterruptable power supply is included for the radio or modem, which can be mounted inside the communications cubicle. Many telemetry protocols can be supported such as DNP3 and IEC 60870-5-101.

## Computer interface

WSOS is an advanced personal computer based software package to allow off-line and on-line programming, monitoring and control of a recloser via a USB port, RS232 port or Ethernet.

## Remote control

The ADVC offers an impressive list of communication ports for use in remote control applications:

- 4 x RS232
- 1 x Ethernet
- 1 x RS485
- 1 x V23.

Customising the operator interface to suit your unique applications has never been easier.

PE55505

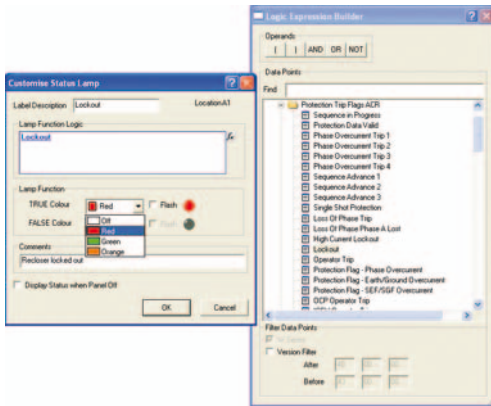

Example of building the logic function for a status lamp

The flexVUE Operator Interface uses Light Emitting Diodes (LED) and an LCD display to communicate the system status to a local operator. Operator actions that are performed on a regular basis can be mapped to 12 dedicated buttons on the interface.

Each of these buttons also have a lamp to indicate the ON/OFF state of each action. Together with the 20 status lamps the panel provides no less than 32 three-colour LEDs that display the state of the controller and overhead system. On the interface, the action buttons are grouped together and referred to as quick action keys. The status LEDs are also grouped together and referred to as status lamps.

Every controller is programmed with a standard configuration of status lamps and quick action keys - text labels are used to mark the function of each. These labels are inserted into special pockets within the flexVUE Operator Interface and can be changed in the field if required.

A graphical panel configuration tool is provided as part of the WSOS 5 software package that will allow full customisation of the flexVUE Operator Interface, if required. With the tool you can create your own logic functions driving the status lamps, as well as change the actions linked to each quick action key. New labels can be printed from the WSOS template using standard office stationery, cut to size and inserted into the controller.

PE55506

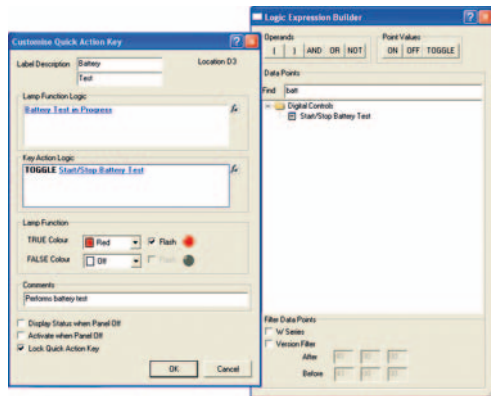

Example of setting the action keys

PE55507

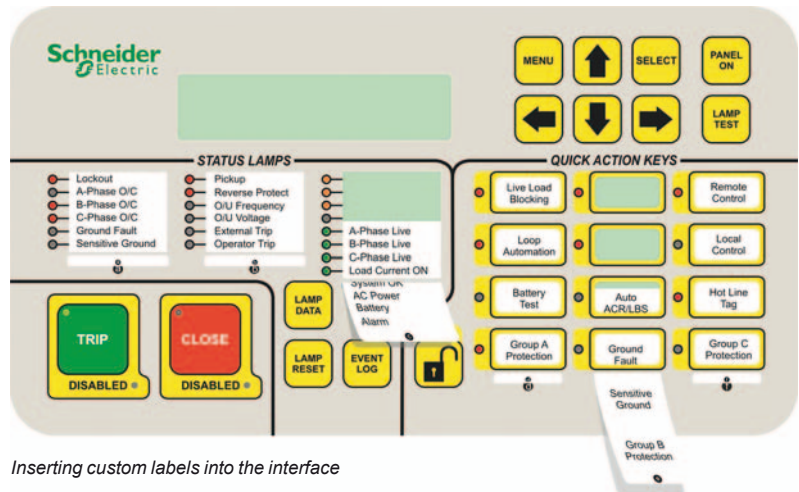

Inserting custom labels into the interface

WSOS is the Schneider Electric switchgear operating system software. It provides easy access to all switchgear functions from opening/closing, through configuring protection and communication parameters to accessing measurement and analytical data.

By using a PC, engineers can manage a large number of reclosers either remotely via a communications link or locally via a USB, serial port or Ethernet connection.

WSOS version 5 integrates Schneider Electric's field proven Windows-based switchgear operating system and its powerful features and tools, developed over many years, into a modern desktop. The desktop includes the switchgear explorer to organise your switchgear the way you like it and the launch pad for handy links to online help, getting started, updates and much, much more. Controlling, configuring and accessing valuable switchgear data from a local or remote location is now even easier than before.

## Local and remote control

- Switchgear operation
- Protection group selection
- Protection group copy
- NPS on/off/alarm control
- Auto reclose, earth protection and SEF on/off control
- Work tag, low gas and dead lockout on/off control
- Configurable Input/Output Expander (IOEX)
- Configurable quick keys
- Configurable delay for local Open and Close operations (Hit and Run)
- Configurable SCADA protocols (e.g. DNP3, 101/104, Modbus, MITS).

## Communication options

- Local USB port (for connection to WSOS only)
- Local RS232 port connection
- Radio modem
- GSM / PSTN modem
- DNP3 virtual terminal object
- TCP/IP
- Communications output capture.

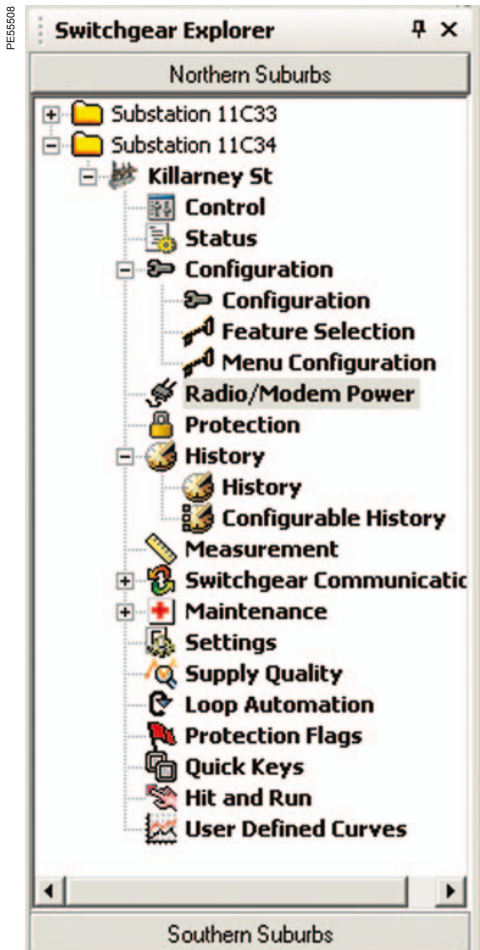

Switchgear Explorer window

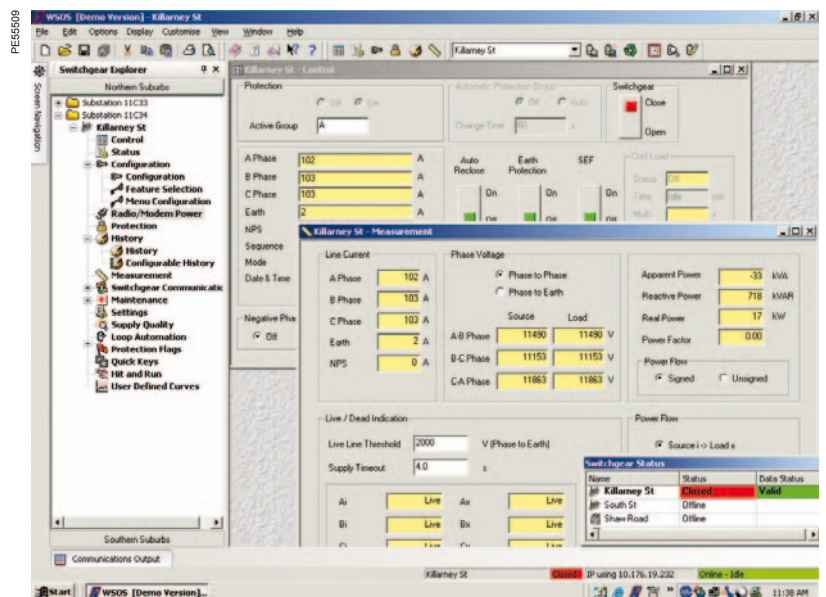

Example of the WSOS5 desktop

## Measurement screens

- Three-phase, earth and sequence current
- Phase voltages:
  - Phase to phase,
  - Phase to earth, and
  - Sequence voltages.
- Phase live/dead indication
- Apparent, reactive & real power:
  - Total, and
  - Per phase.
- Power factor
- Signed or unsigned power
- Frequency
- Power quality toolkit:
  - Waveform capture
  - Harmonics.

## Interface configuration

- Status lamps:
  - Logic function to indicate; and
  - Separate true/false state colour configuration.
- Quick action keys:
  - Customise actions assigned to each key
  - Custom logic functions for lamp indication, and
  - Separate true/false colour configuration.
- Print labels to insert into operator interface.

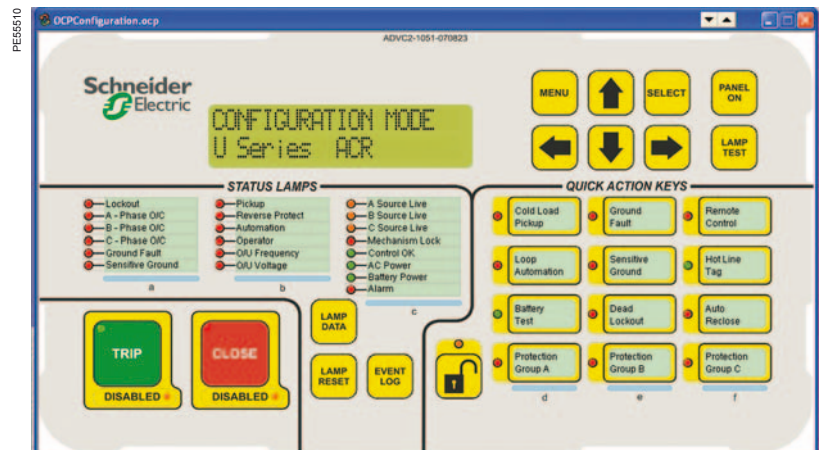

Example of panel configuration tool

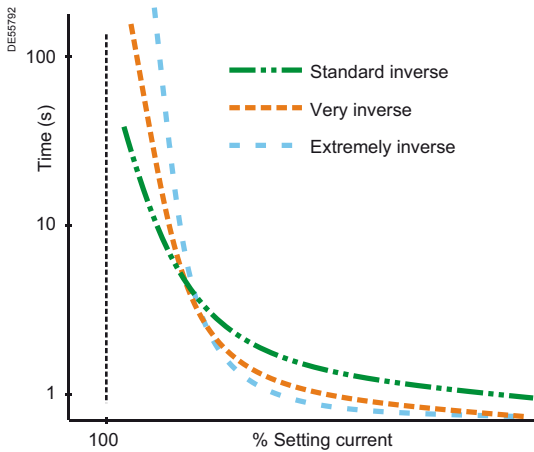

Inverse time curves

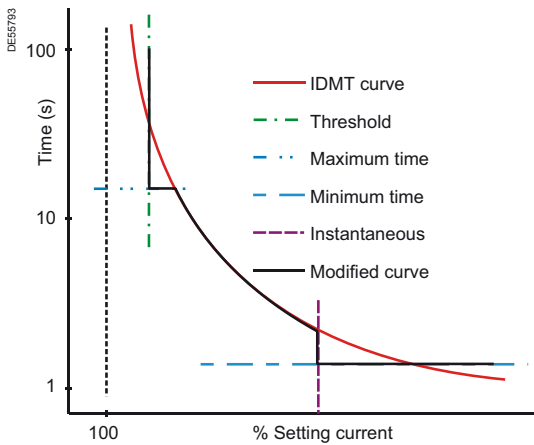

Modified curve

## Operating sequence

Reclose times are individually selectable. The operating sequence is defined by:  
 O - 1st rt - CO - 2nd rt - CO - 3rd rt - CO where rt = reclose time.  
 where O = open.  
 where C = close.

## Reclose times

- 1st reclose time range: 0.5 - 180 s
- 2nd reclose time range: 2.0 - 180 s
- 3rd reclose time range: 2.0 - 180 s
- Timing resolution: 0.1 s

## Sequence reset time

- Sequence reset time: 3 - 180 s
- Timing resolution: 1 s

## Trips to lockout

Overcurrent and fault trips to lockout are selectable between 1 and 4. A separate setting is available for sensitive earth fault and negative phase sequence.

## Inverse time curves

The ADVC offers a total of 48 user selectable inverse time protection curves. These are:

- Three IEC60255 curves: Inverse, Very Inverse and Extremely Inverse.
- Three IEEE C37.112 Inverse Time curves: Moderately Inverse, Very Inverse and Extremely Inverse.
- 42 Non Standard Inverse Time curves: Refer to the Operating Manual for a full listing.

## Instantaneous protection

Instantaneous protection works by tripping the recloser if the line current exceeds the Instantaneous Multiplier x Setting Current.

- Multiplier range: 1 - 30
- Resolution of setting: 0.1
- Max. effective setting: 12.5 kA

## Definite time protection

Definite time is an alternative to inverse time protection. It works by tripping the recloser at a fixed time after pick-up.

- Setting current range: 10 - 1260 A
- Definite time resolution: 0.1 s
- Definite time range: 0.01 - 100 s
- Setting current resolution: 1 A

## Sensitive Earth Fault (SEF)

SEF causes the recloser to trip when the earth current rises above a set level for longer than the set time.

- SEF trip current range: 4 - 20 A
- SEF operating time range: 0.1 - 999 s
- SEF trip current setting resolution: 1 A
- SEF operating time resolution: 0.1 s



## Inrush restraint

Inrush restraint raises the phase and earth threshold currents for a short period of time to allow for short duration inrush currents when closing onto a load.

- Multiplier range: 1 - 30
- Multiplier resolution: 0.1
- Time range: 0.05 - 30 s
- Time resolution: 0.05 s

## Cold load pick-up

Cold load pick-up allows for a loss of diversity when a load has been without supply for a period of time.

- Multiplier range: 1 - 5
- Multiplier resolution: 0.1
- Time constant range: 1 - 480 min.
- Time constant resolution: 1 min.

## Multiple protection groups

The ADVC supports up to 10 protection groups, each of which can be configured with completely separate protection characteristics with different inverse time curves and setting currents. The number of protection groups available to the operator can be configured using WSOS, thereby restricting or enabling access to protection settings as required.

## Automatic protection group selection

Automatic Protection Group Selection (APGS) is used to change the protection group depending on the direction of power flow. This allows the recloser to be correctly graded with devices downstream regardless of the power flow direction.

## Loss of phase

Loss of phase protection trips the recloser if phase-earth voltage on one or two phases falls below a set voltage threshold for a set length of time.

- Threshold voltage range: 2 - 15 kV
- Voltage resolution: 1 V
- Time range: 0.1 - 100 s
- Time resolution: 0.1 s

## Live load blocking

Live load blocking prevents a recloser from closing if any of the load side terminals are live.

- Live load threshold voltage range: 2 - 15 kV

## Dead lockout

Dead lockout prevents a reclose unless one or more of the source side or load side terminals are live. If all terminals are dead then the controller goes to lockout.

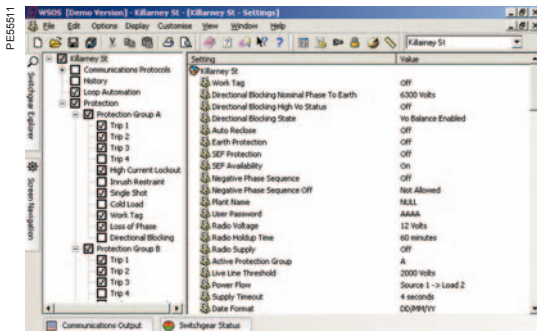

WSOS offers a quick, easy way to configure the protection groups

## Directional blocking

Directional blocking is a protection feature that restricts tripping on faults to a designated side of the recloser. It prevents nuisance tripping if particular network conditions are causing "false" earth faults. In radial systems, directional blocking prevents nuisance tripping by blocking faults in the source direction and only responding to faults in the load direction.

## Directional protection

Distinct protection for faults in the forward and reverse direction. A forward fault may use a different time-current curve and settings to a reverse fault (i.e. these are individually selectable). Both the forward protection and reverse protection are operating at the same time. This is an additional protection feature.

## Sequence components

Negative, positive and zero phase sequence currents and voltages can be monitored and logged.

In addition, the negative phase sequence current protection can be used for detection of low-level phase-to-phase faults in the presence of high level three-phase loads. Inverse Time, Definite Time and Instantaneous operation is available.

- Setting current range: 10 - 1260 A

## Sequence coordination

Sequence coordination allows a recloser to coordinate its trip sequence with another recloser downstream.

## Under / over frequency protection

This feature trips the recloser when the system frequency exceeds the under and over frequency trip threshold values. Frequency tripping range: 45 - 65 Hz

- Frequency calculation: Once per cycle over a two cycle period
- Number of under/over frequency cycles before tripping: 2 - 1000
- Accuracy:  $\pm 0.05$  Hz

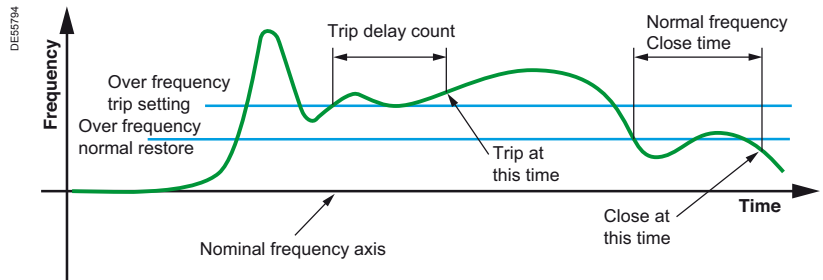

Under / over frequency protection

## Under / over voltage protection

When selected, and a nominal phase to earth system operating voltage is set, the UOV Protection works within a defined threshold above and below the specified voltage.

- Under voltage lower threshold range: 50% - 88%
- Over voltage upper threshold range: 112% - 150%
- Trip after X s range: 0 - 300 s
- Phase logic
  - AND: when ALL phases deviate beyond thresholds
  - OR: when ANY phase voltage deviates beyond the thresholds
  - AVERAGE: when the numerical AVERAGE of all phase voltages deviates beyond the threshold.





### Voltage & current

True RMS voltage is measured on all six terminals. A user-configured threshold indicates a live terminal (accuracy  $\pm 2.5\%$ ).  
RMS current is measured on three phases (reading 2 - 800 A).

### Real power (signed or unsigned)

Real power is determined by multiplying the line voltage and line current in real time and averaging over 2 seconds (accuracy  $\pm 5\%$  of reading, within limits of V and I above).

### Power & power factor

The ADVC controller measures kW, kVA, kVAR and powerfactor on a per-phase basis. The power factor of the line is determined from the line voltage and the line current phase relationship and the previously calculated real power (accuracy  $\pm 5\%$  of reading, within limits of V and I above).

### Default historical measurements

Power flow is integrated over 5, 15, 30, or 60 minute intervals (kWh) and recorded for two months at the default setting. This can be viewed on the operator control panel, computer, or compatible SCADA system. Additionally, data can be uploaded into a portable computer or a compatible SCADA system.

### Configurable historical measurements

Average demand profiles may be configured using WSOS. Customised configuration enables the user to specify only the parameters that are required, negating unnecessary information capture. Parameters such as line voltages and currents, power, kWh, battery voltage and cubicle temperature can be recorded in intervals selectable between 1 and 1440 min.

### Event history

- Maximum number of typical events stored in the event history: 30,000 events.

### Gas pressure measurement

- Gas pressure display resolution: 5 kPa
- Gas pressure display accuracy:  $\pm 10$  kPa
- Gas low alarm setting: 65 kPa Gauge at 20°C
- Gas low alarm/interlock accuracy:  $\pm 10$  kPa

### Power quality toolkit

- Supply outage measurement:
  - The supply outage measurement feature utilises built-in recloser features to record the number and duration of outages. These statistics are recorded in the controller and are available to the utility to help calculate system outage customer minutes.
  - The controller records:
    - cumulative total number of outages
    - cumulative total outage duration, and
    - the time and duration of each outage event in the event log.
  - These records are accessible to the user and can be retrieved using the operator control panel, WSOS or a SCADA system.
- Harmonic analysis:
  - Harmonics 2 to 16 and the Total Harmonic Distortion (THD) are calculated over an 80 ms period for four currents, six line-line voltages and six line-earth voltages. These harmonics are available via WSOS.
- Waveform capture
  - Based on a user defined trigger, the ADVC captures and stores, in non-volatile memory, scaled raw data (10 x 3200 samples per second) of the six line-earth voltages and four currents for a predefined time window either side of a user-defined trigger.
  - The user can configure a pre and post trigger time ratio for data to be stored. This defaults to 50% pre-trigger and 50% post-trigger.
  - The captured data can be uploaded at anytime in COMTRADE (IEEE Std C37.111-1999) format via WSOS.

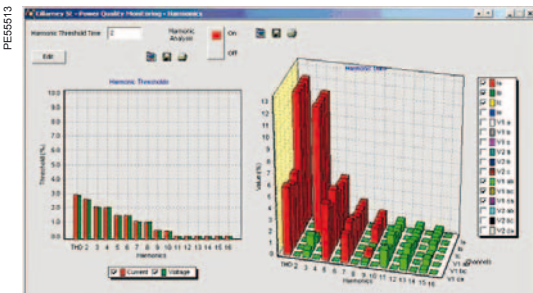

Harmonic analysis

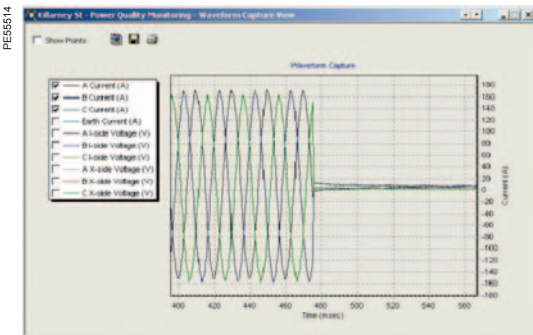

Waveform capture

# N-Series recloser Pole mounting details

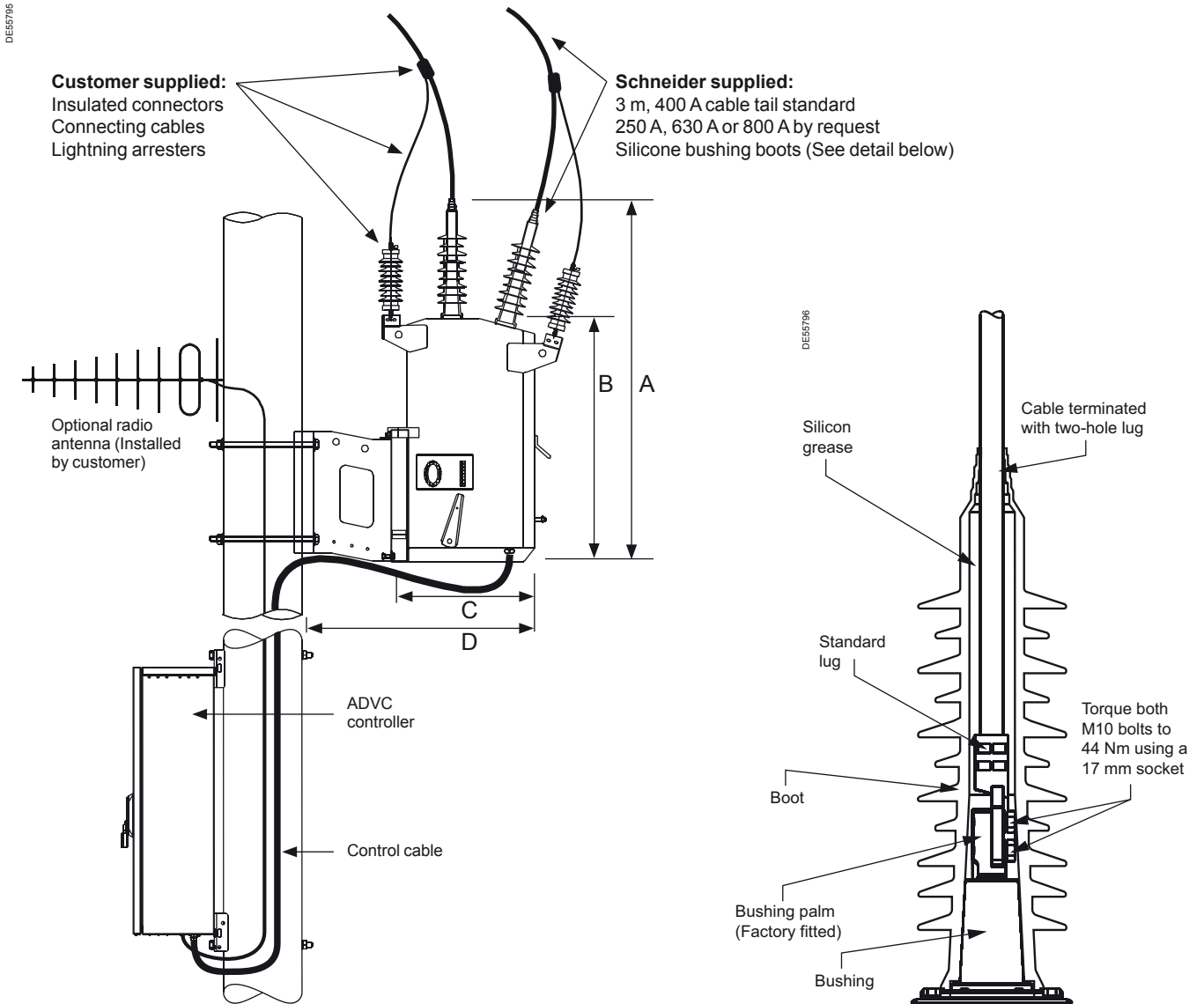

N-Series model	Rated voltage	A (mm/in)	B (mm/in)	C (mm/in)	D (mm/in)
N15	15.5 kV	1370 / 54.9	898 / 35.3	525 / 22.1	880 / 33.6
N27	27 kV	1370 / 54.9	898 / 35.3	525 / 22.1	880 / 33.6
N38	38 kV	1410 / 55.5	898 / 35.3	525 / 22.1	955 / 37.5

**Notes**

- (1) Details given in this illustration are subject to change without notice. For full details see the Installation Manual.
- (2) Earthing connections are not shown and are to be in accordance with the Installation Manual.
- (3) Recloser can be mounted closer to pole if lightning arresters are pole mounted.
- (4) Optional substation mounting frame available on request.

		N-Series			
		15 kV 12.5 kA	27 kV 12.5 kA	38 kV 12.5 kA	38 kV 16 kA
<b>Ratings</b>					
Rated maximum voltage	kV	15.5	27	38	38
Rated nominal voltage (Phase to ground)	kV				
Rated continuous current	A	800	800	800	800
Emergency current (8 hours)	A	850	850	850	850
Fault make capacity (RMS)	kA	12.5	12.5	12.5	16
Fault make capacity (Peak)	kA	31.5	31.5	31.5	40
Power operating time (Close / Open)	s	0.1 / 0.05	0.1 / 0.05	0.1 / 0.05	0.1 / 0.05
Mechanical operations		10 000	10 000	10 000	10 000
Rated full load operations		10 000	10 000	10 000	10 000
Short time current	kA	12.5	12.5	12.5	16
<b>Breaking capacity</b>					
Mainly active (0.7 pf)	A	800	800	800	800
Fault break capacity	kA	12.5	12.5	12.5	16
Cable charging	A	25	25	25	40
Line charging	A	5	5	25	40
Transformer magnetising	A	22	22	22	22
Capacitor bank	A	250	250		
<b>Lightning impulse withstand level</b>					
Phase to phase	kV				
Phase to earth	kV	110	150	170	170
Across interrupter	kV	110	150	170	170
On loss of SF6	kV	60	70	70	70
<b>Power frequency withstand voltage</b>					
Phase to earth	kV	50	60	70	70
Across interrupter	kV	50	60	70	70
<b>Service conditions</b>					
Ambient temperature <sup>(1)</sup>	°C	-40 to 50	-40 to 50	-40 to 50	-40 to 50
	°F	-40 to 122	-40 to 122	-40 to 122	-40 to 122
Radiation (Max.)	kW/m <sup>2</sup>	1.1	1.1	1.1	1.1
Humidity	%	0 to 100	0 to 100	0 to 100	0 to 100
Altitude meters (Max. <sup>(2)</sup> )	m	3000	3000	3000	3000
Altitude feet (Max. <sup>(2)</sup> )	ft	9840	9840	9840	9840
<b>Net weights</b>					
Circuit breaker with pole mount bracket	kg / lbs	249 / 549	249 / 549	249 / 549	249 / 549
Control cubicle with control cable	kg / lbs	41 / 90	41 / 90	41 / 90	41 / 90
Gross weight of crate	kg / lbs	404 / 891	404 / 891	404 / 891	404 / 891
External VT (N series only)	kg / lbs	60 / 132	60 / 132	60 / 132	60 / 132
<b>Crate dimensions</b>					
Width	mm / in	1160 / 45.7	1160 / 45.7	1160 / 45.7	1160 / 45.7
Depth	mm / in	730 / 28.7	730 / 28.7	730 / 28.7	730 / 28.7
Height	mm / in	1640 / 64.6	1640 / 64.6	1640 / 64.6	1640 / 64.6

(1) Option when cubicle battery heater is fitted (-10°C to 50°C [-14°F to 122°F] without heater)

(2) For altitudes above 1000 m (3280 feet), derate in accordance with ANSI C37.60 for reclosers (ANSI C37.63 for LBS)

# Required details for order

## N-Series Automatic Circuit Recloser

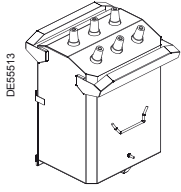

Only one of the boxes (ticked  or filled ) with the required value) have to be considered between each horizontal line.

Red circle  lead-time should be requested from your distributor.

*Certain configurations may attract additional cost. To clarify these details, please consult your local distributor.*

Circuit breaker unit		Quantity
<b>Rating</b> (System voltage / Interrupt / BIL)	15.5 kV / 12.5 kA / 110 kV <input type="checkbox"/>	38 kV / 12.5 kA / 170 kV <input type="checkbox"/>
	27 kV / 12.5 kA / 150 kV <input type="checkbox"/>	38 kV / 16 kA / 170 kV <input type="checkbox"/>
<b>Rated current (A)</b>	630 A <input type="checkbox"/>	800 A <input type="checkbox"/>
<b>Frequency</b>	50 Hz <input type="checkbox"/>	60 Hz <input type="checkbox"/>
<b>Sensitive earth fault rating</b>	4 - 20 A (default) <input type="checkbox"/>	1 - 20 A <input checked="" type="checkbox"/>
<b>Additional CT's inside switch tank</b> (Additional cost may apply)	Not applicable <input type="checkbox"/>	200/100/1 <input type="checkbox"/>
	600/300/1 <input type="checkbox"/>	800/400/1 <input type="checkbox"/>
<b>Rating plate language</b>	English <input type="checkbox"/>	Spanish <input checked="" type="checkbox"/>
		Portugese <input checked="" type="checkbox"/>
<b>Switch state indication</b>	ON / OFF <input type="checkbox"/>	I / O <input checked="" type="checkbox"/>
<b>VT mounting</b>	Not applicable <input type="checkbox"/>	Tank mounted <input type="checkbox"/>
		Pole mounted <input type="checkbox"/>
Accessories		
<b>Mounting arrangement</b>	Pole mount:	B type (15 - 27 kV) <input type="checkbox"/>
		C type (38 kV) <input type="checkbox"/>
	Substation frame:	Adjustable <input type="checkbox"/>
		Fixed <input type="checkbox"/>
<b>Concrete pole clamps</b>	Not applicable <input type="checkbox"/>	230 - 270 mm <input type="checkbox"/>
		270 - 310 mm <input type="checkbox"/>
		310 - 360 mm <input type="checkbox"/>
<b>Control cable length</b>	7 metres (Default) <input type="checkbox"/>	11 metres <input type="checkbox"/>
		(Max) 20 metres <input type="checkbox"/>
		Other <input checked="" type="checkbox"/>
<b>Bushing boots</b> (Set of 6)	Not applicable <input type="checkbox"/>	770 mm (15-27 kV) <input type="checkbox"/>
		1100 mm (38 kV) <input type="checkbox"/>
Options		
<b>Terminal cable length</b> (Set of 6)	3 metres <input type="checkbox"/>	4 metres <input type="checkbox"/>
	5 metres <input type="checkbox"/>	6 metres <input type="checkbox"/>
	Not applicable <input type="checkbox"/>	Other <input checked="" type="checkbox"/>
<b>Terminal cable rating</b>	Not applicable <input type="checkbox"/>	250 A (Aluminium) <input type="checkbox"/>
		400 A (Aluminium) <input type="checkbox"/>
		630 A (Aluminium) <input type="checkbox"/>
		800 A (Copper) <input type="checkbox"/>
<b>Surge arresters</b>		Not applicable <input type="checkbox"/>
		Surge arresters <input type="checkbox"/>
<b>Voltage transformers</b>	Primary side:	Vp-p 11 kV <input type="checkbox"/>
		Vp-p 22 kV <input type="checkbox"/>
		Vp-p 33 kV <input type="checkbox"/>
	Not applicable <input type="checkbox"/>	Secondary side:
		27.8 V <input type="checkbox"/>
		115 V <input type="checkbox"/>
		230 V <input type="checkbox"/>
<b>Dressing</b> (Australia only)		Not applicable <input type="checkbox"/>
		Dressed <input checked="" type="checkbox"/>
Special notes		











**Schneider Electric Industries SAS**

335, rue Joseph Monier  
CS 30323  
F - 92506 Rueil Malmaison Cedex (France)  
Tel.: +33 (0)1 41 29 70 00  
RCS Nanterre 954 503 439  
Capital social 896 313 776 €  
[www.schneider-electric.com](http://www.schneider-electric.com)

As standards, specifications and designs change from time to time, please ask for confirmation of the information given in this publication.

Design: Schneider Electric Industries SAS  
Photos: Schneider Electric Industries SAS  
Printed: Altavia St-Etienne - Made in France



 *This document has been printed on recycled paper*